



Central Coast Council

# Street Banner Guide









---

# Contents

---

Introduction.....	4
Booking Process.....	4
Design Guidelines.....	5
Banner Pole Locations.....	6
Banner Stand Locations.....	13
Banner Fabrication Specifications.....	13
Installation and De-Installation.....	18

# Introduction

The purpose of this guide is to provide information to external organisations who wish to utilise Central Coast Council's banner infrastructure and should be read in conjunction with Council's Street Banner Policy.

Council banner sites are available for temporary use by both Council departments and external organisations to publicise events and activities considered appropriate by Council. External organisations can apply to utilise banner sites when not in use by Council.

## Guide Objectives

The objectives of this Guide are to:

- Outline the administration of the banner program
- Define the current locations of banner poles and stands available across the Central Coast
- Provide design guidelines and specifications for banners
- Provide production specifications for banners

# Booking Process

Hirers to complete Council's banner application form on Council website and submit for consideration a minimum of twelve (12) weeks prior to anticipated installation date.

Banner allocations are subject to availability and submission of an application does not guarantee use of sites unless approval is provided by Council in writing.

# Key Dates

Minimum 12 weeks prior to proposed install date	Submit application to Council. Application outcome to be confirmed within 7 days.
8 weeks prior to confirmed install date	Submit banner design to Council for approval. Outcome to be confirmed within 7 days.
1 week prior to confirmed install date	Arrange delivery of banners and install brief to Council's nominated location
Within 4 weeks of de-install date	Collect banners from Council's nominated location



# Design Guidelines

All designs for street banners need to meet the design standards and be approved by Council prior to production. Design standards include:

- Designs are prohibited to advertise commercial products or services or political campaigns. Use of organisation logos to indicate sponsorship of events is permissible.
- Recommended use of bold graphics, images and colours. Your designs should be vibrant and contribute to the overall amenity of the streetscape.
- Use a high degree of contrast between text colour and background colour and use legible fonts so banners are accessible to read for everyone.
- Designs must meet industry standard accessibility requirements in terms of layout, colour, font and image selection.
- Avoid using dates on your designs if you would like the banners to be re-used.
- Up to three (3) different designs can be used on street banner poles at a time per campaign.
- One (1) design can be used on banner stands at a time per campaign.
- Designs incorporating offensive, illegal or discriminatory language, symbols or imagery are prohibited.
- Banners may be used to display the Australian, Aboriginal and Torres Strait Islander flag in accordance with the requirements outlined within Council's Banner Policy and Flying of Flags Policy.
- Please note fabricators will have printing specifications for designs including bleed, resolution and design element requirements and it is the responsibility of the Hirer to understand these from their nominated printing supplier.

Council reserves the right to reject any banner design that does not comply with this guide, the *Street Banner Policy* or is considered unsuitable. Council is the final arbiter of what constitutes unsuitable.

# Banner Pole Locations

There are currently eleven (11) Council operated street banner pole locations across the Central Coast region:

Location	Size (mm)	Number of Flags	Details
Ettalong	1000 x 3000mm	10	Ocean View Road & Picnic Parade
Umina	800 x 2500mm	40	West Street
Woy Woy	800 x 2500mm	7	The Boulevarde
Terrigal	800 x 2500mm	27	Scenic Highway & The Esplanade
Gosford	800 x 2500mm	44	Mann Street & Donnison Street
Brian McGowan Bridge	800 x 2500mm	24	Gosford
Long Jetty	900 x 2700mm	50	The Entrance Road
Toukley	900 x 2700mm	14	Main Road & The Village Green
The Entrance	1500 x 4000mm	16	The Entrance Road & Marine Parade
Wyong	800 x 2500mm	9	Pacific Highway & Alison Road
Tuggerah Straight	800 x 2500mm	42 (21 double sided poles)	Pacific Highway

# Ettalong – 10 poles

(2 x at Picnic Pde & 8 x along Ocean View Dr)

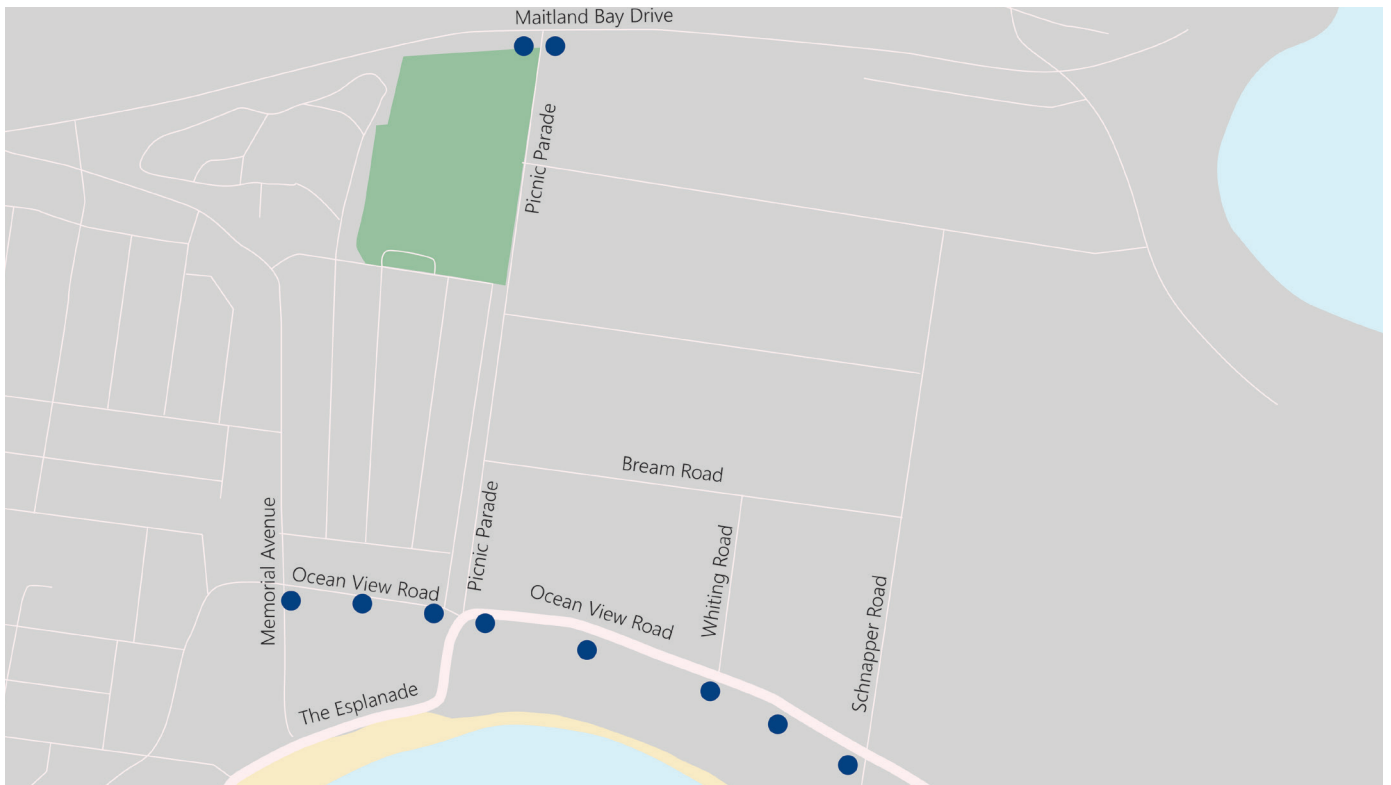

# Umina – 40 flags



# Woy Woy – 7 poles



# Terrigal – 27 flags





## Gosford (Town Centre) – 44 flags

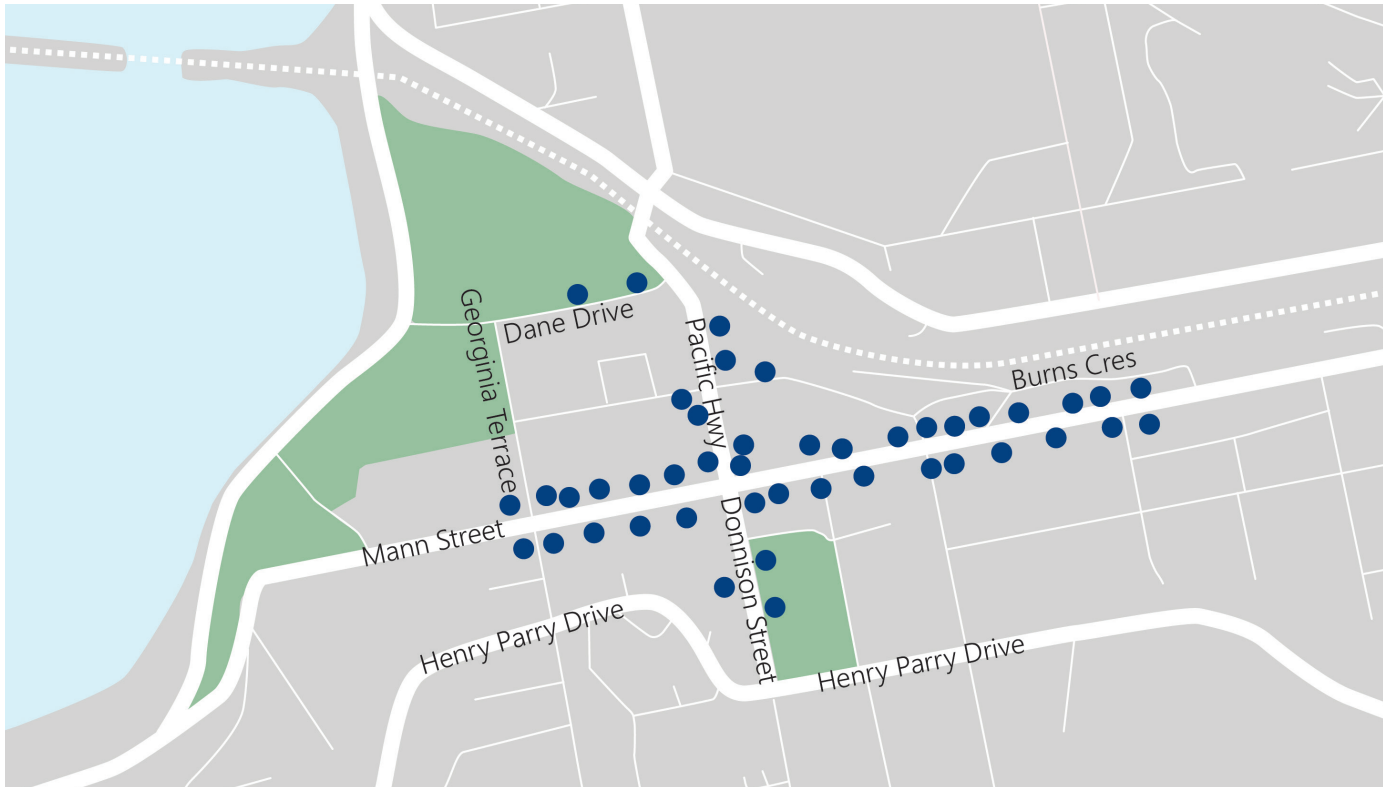

## Brian McGowan Bridge Gosford – 24 flags across bridge

(12 either side)

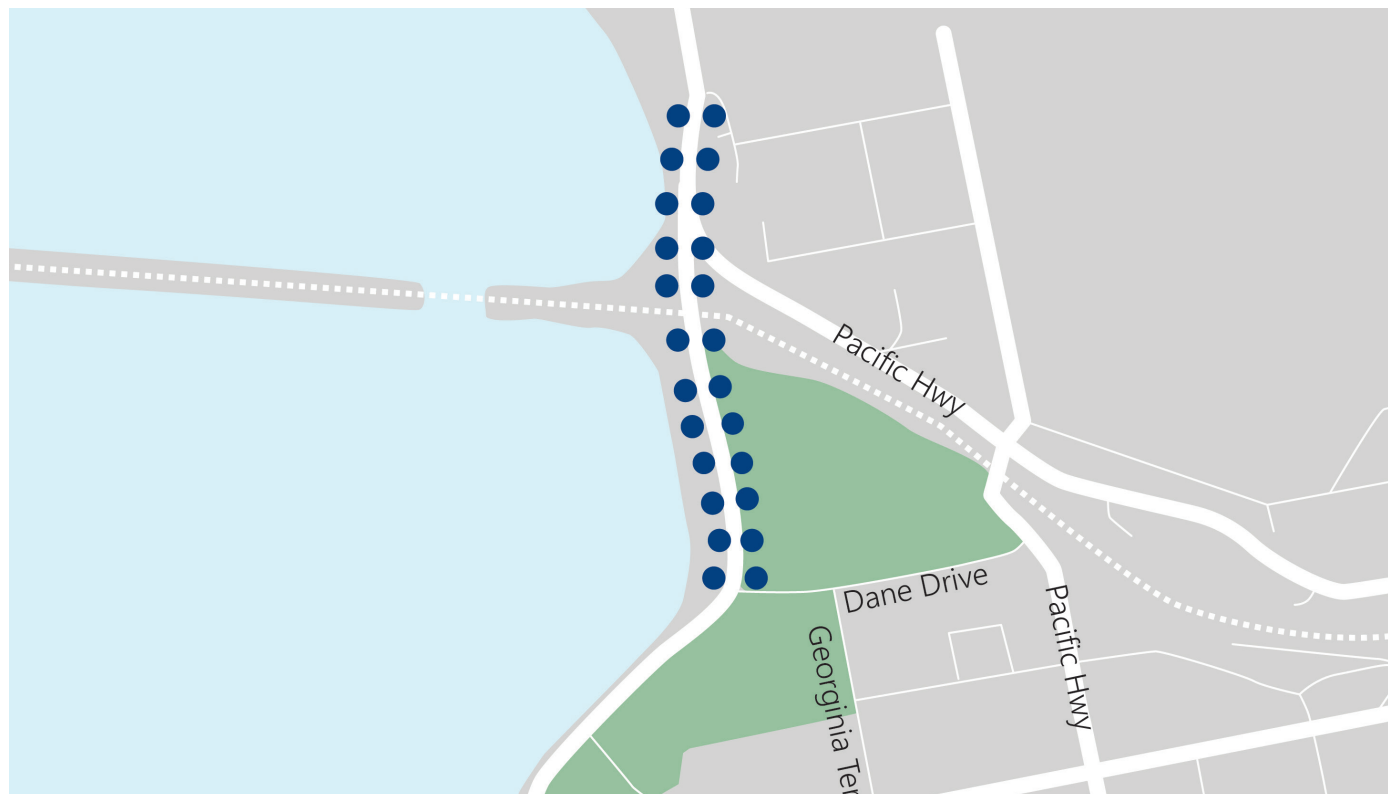

# Long Jetty – 50 poles across 2 zones

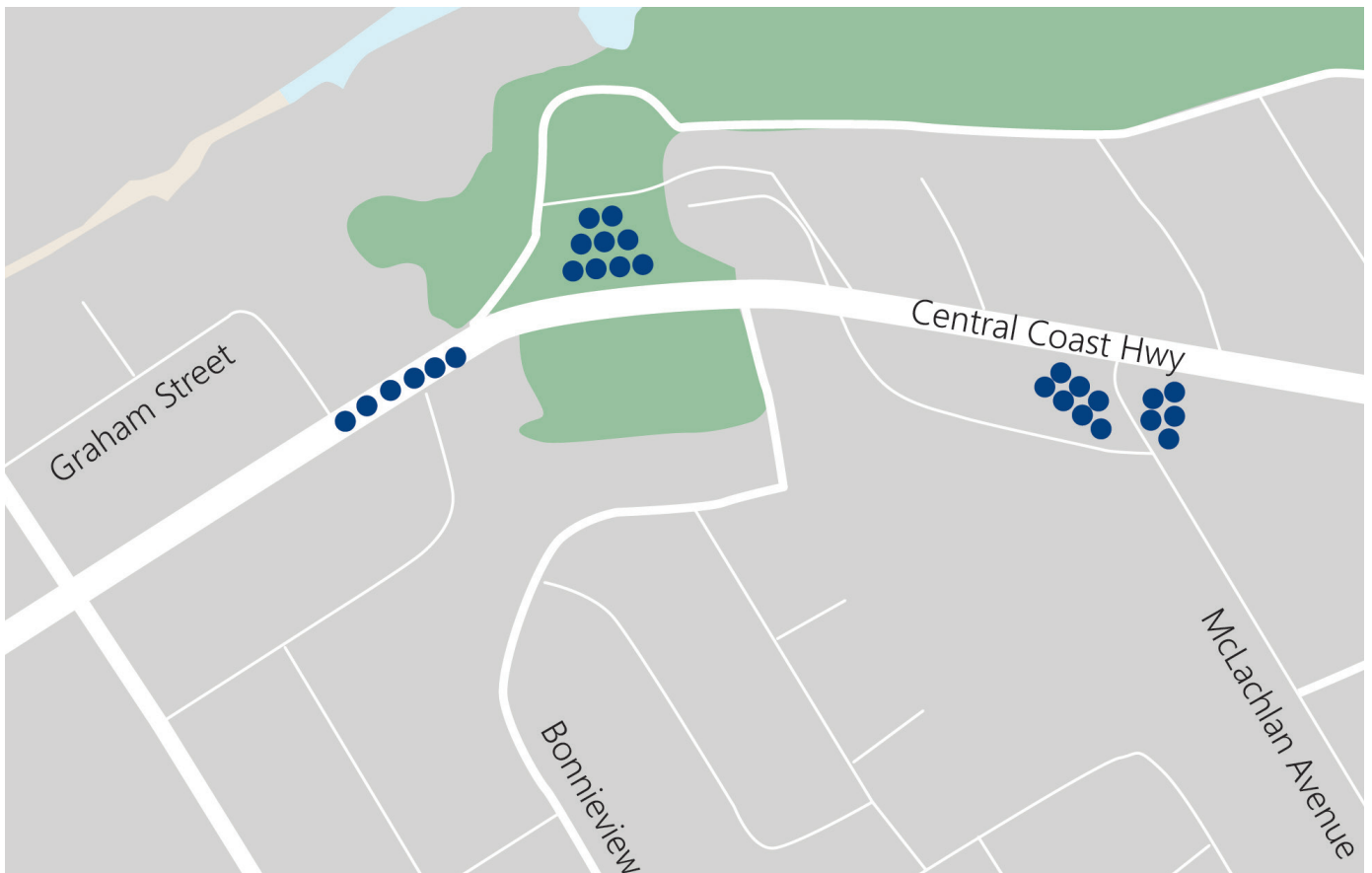
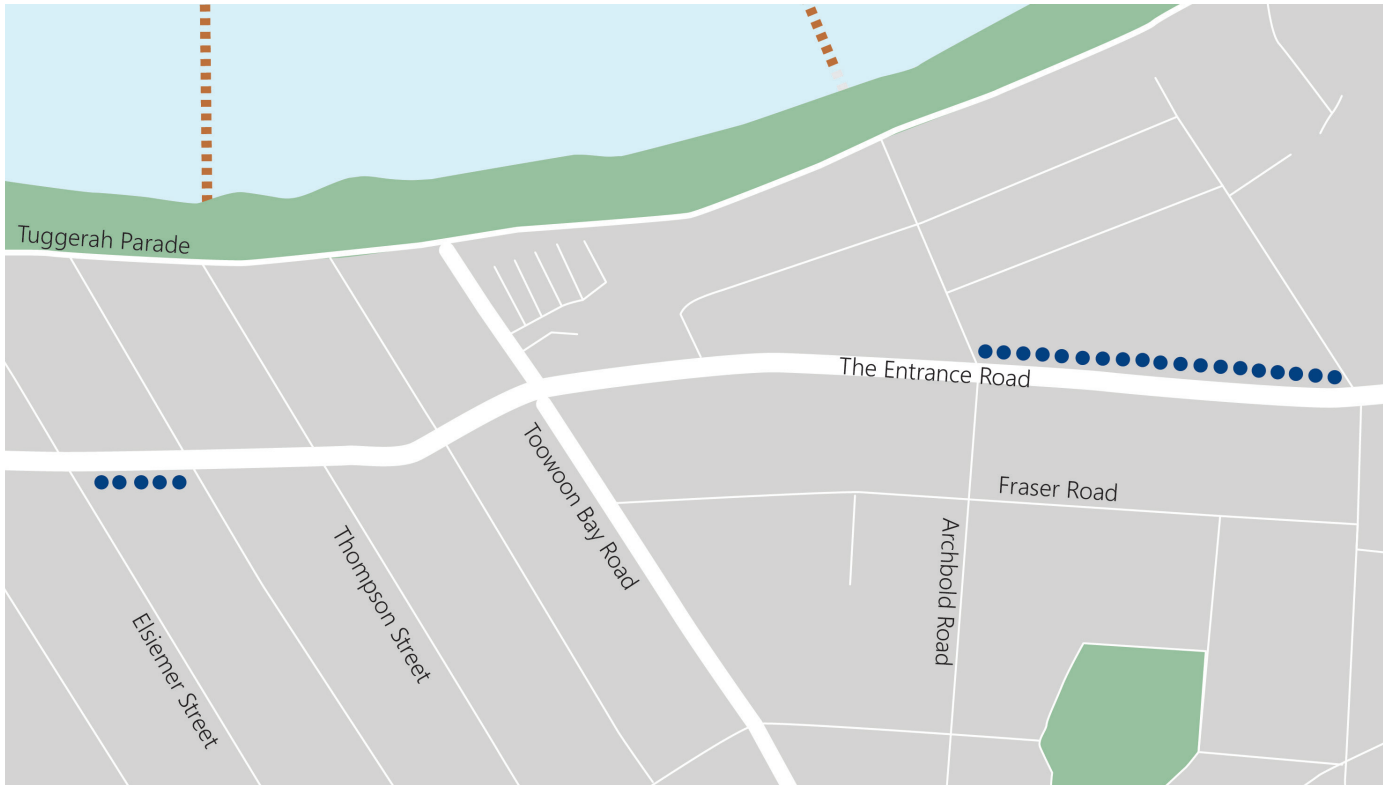

## Toukley – 14 poles

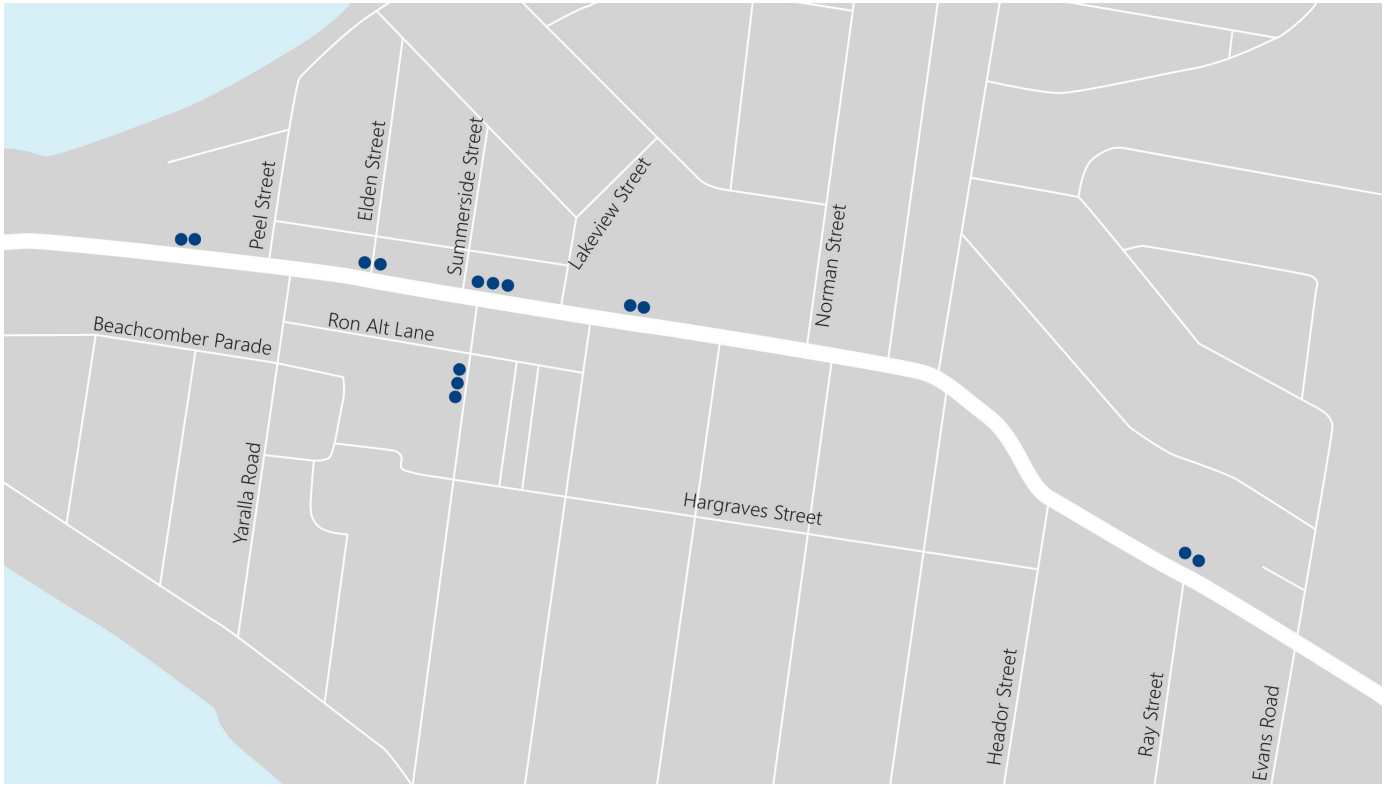

## The Entrance – 16 poles

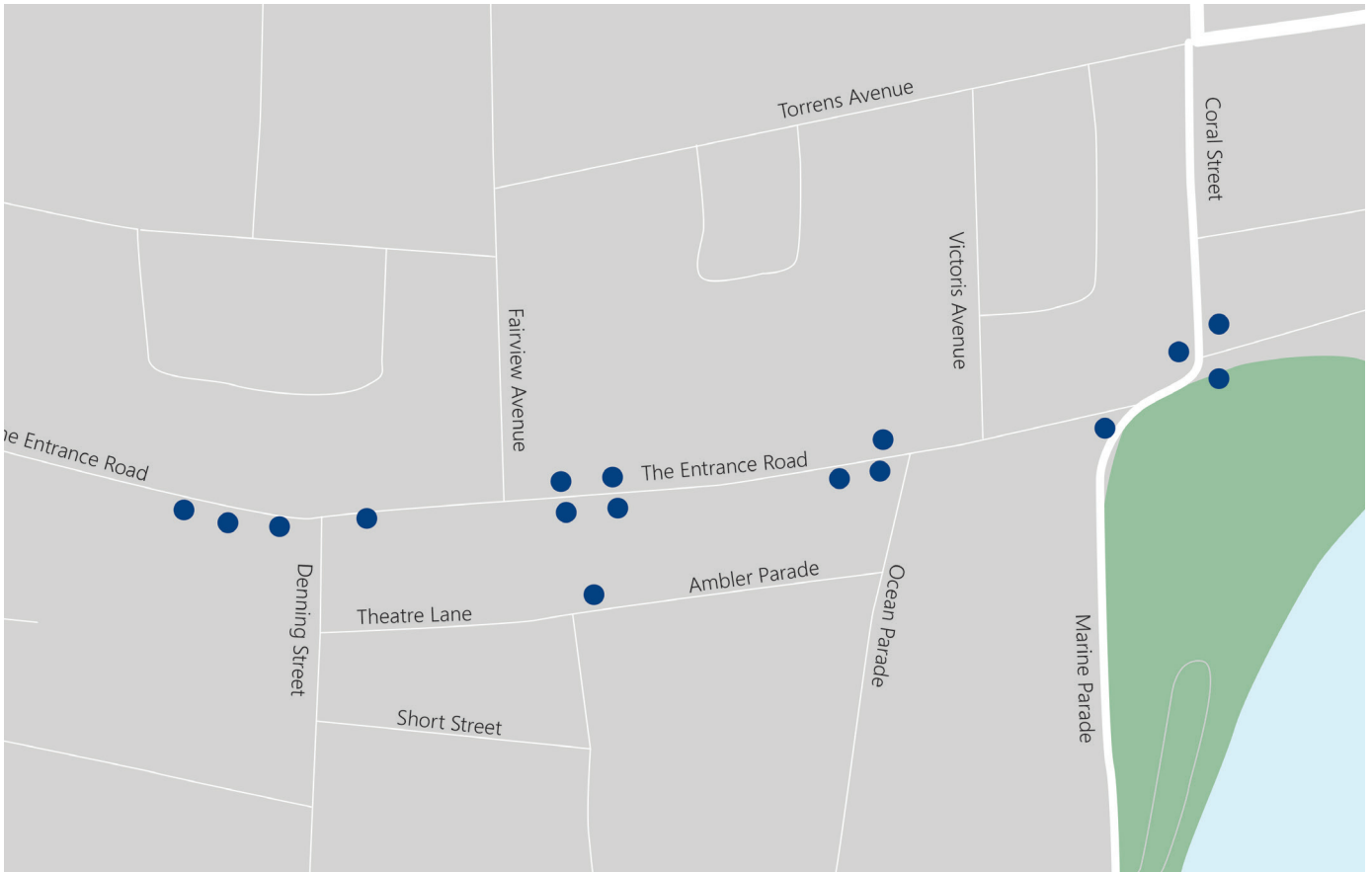

## Wyong – 9 flags

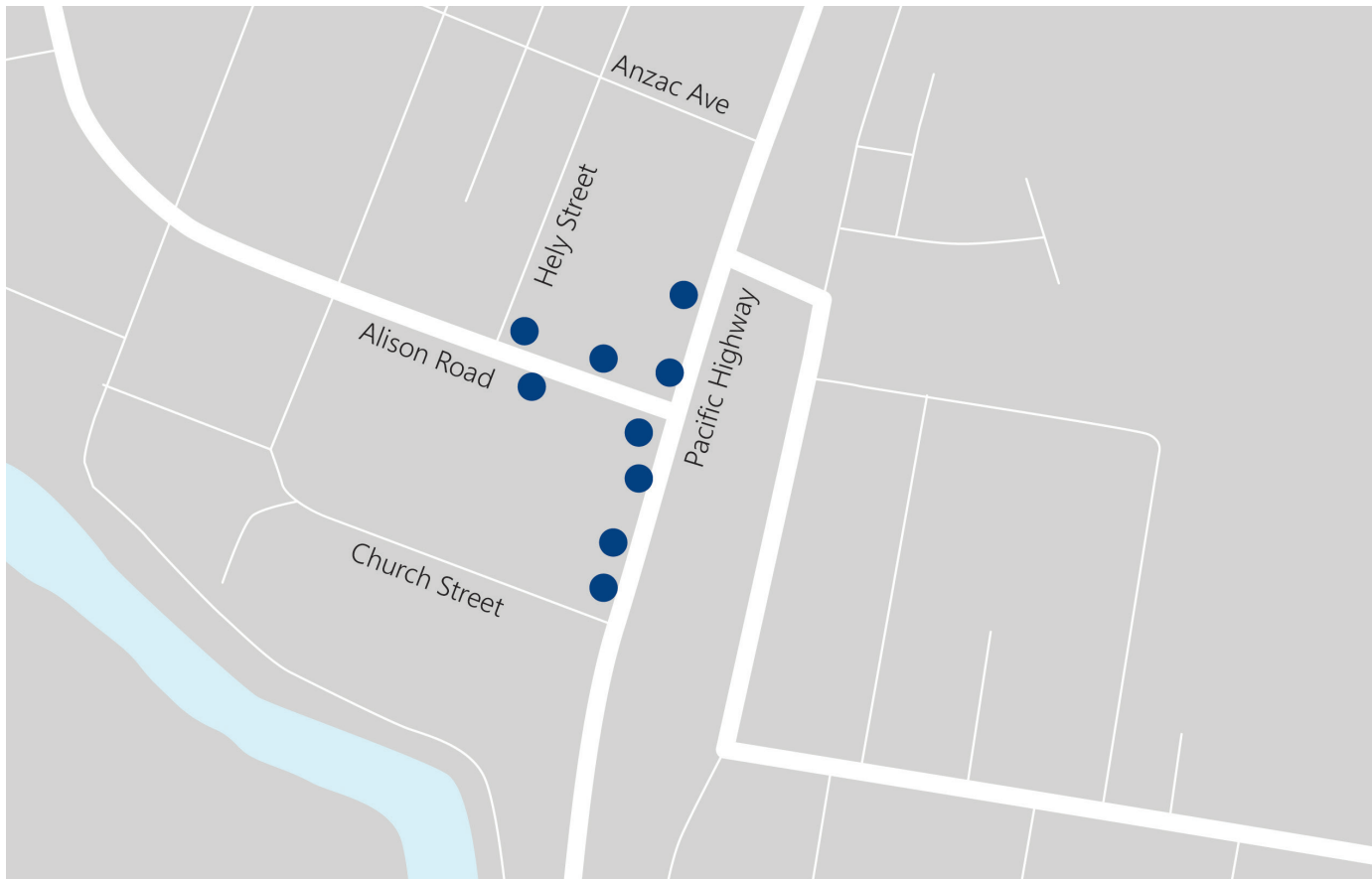

## Tuggerah Straight – 21 poles

(42 flags – 2 x per pole)

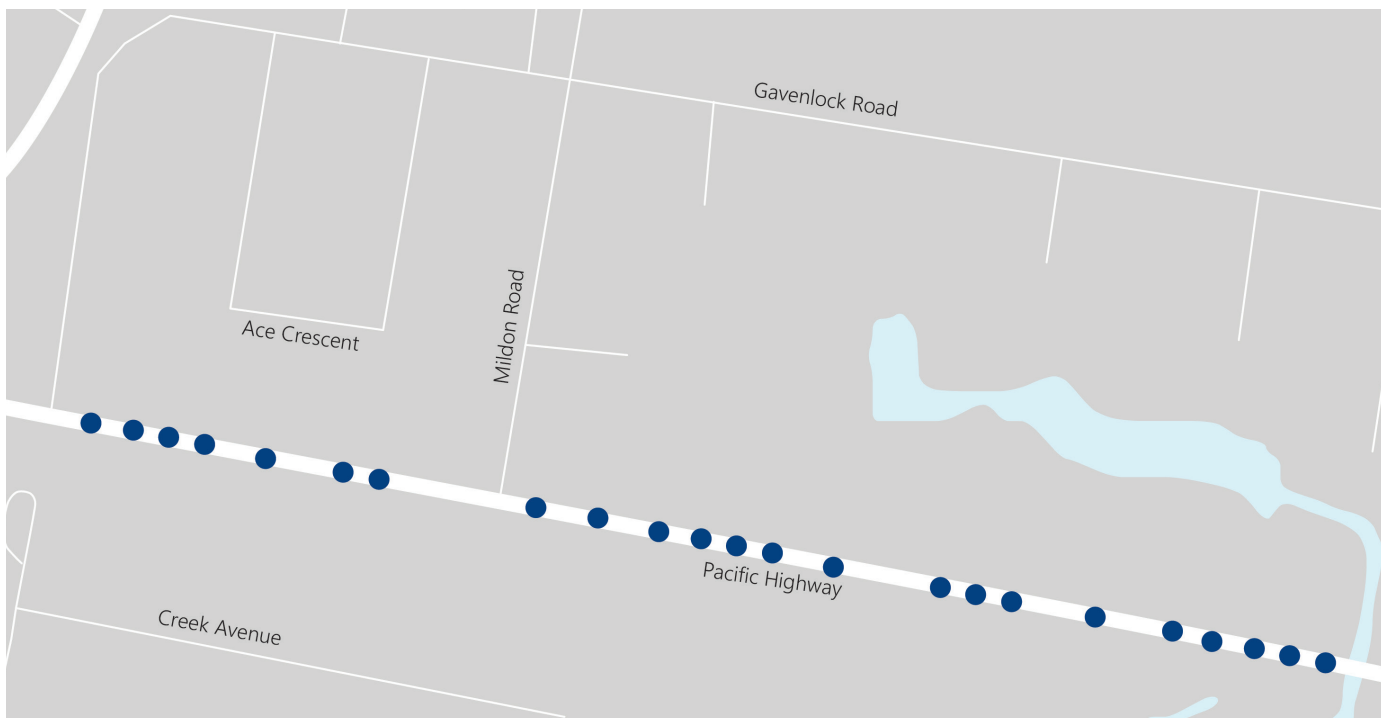



# Banner Stand Locations

There are currently seven (7) Council operated banner stand locations across the Central Coast region:

Location	Size (mm)	Details
West Gosford	1000 x 5500mm	Central Coast Highway opposite Hely Street
Gosford Waterfront	1000 x 5500mm	Masons Parade in Public Reserve opposite waterfront
Woy Woy	1000 x 5500mm	Ocean Beach Rd opposite McMasters Road
Forresters Beach	1000 x 5500mm	The Entrance Road opposite Bakali Street
Erina	1000 x 5500mm	Corner of Avoca Drive and Central Coast Highway
Kincumber	1000 x 5500mm	Corner of Davies Street and Avoca Drive
Long Jetty	1000 x 5500mm	Saltwater Creek Park

# Banner Fabrication Specifications

Fabrication of banners is the responsibility of the Hirer. Council provide specifications as a guide only and further printing advice should be sought from their chosen supplier.

# Banner Poles

There are 4 x different banner pole sizes for banner poles across the LGA:

## 800 x 2500mm Banner Pole

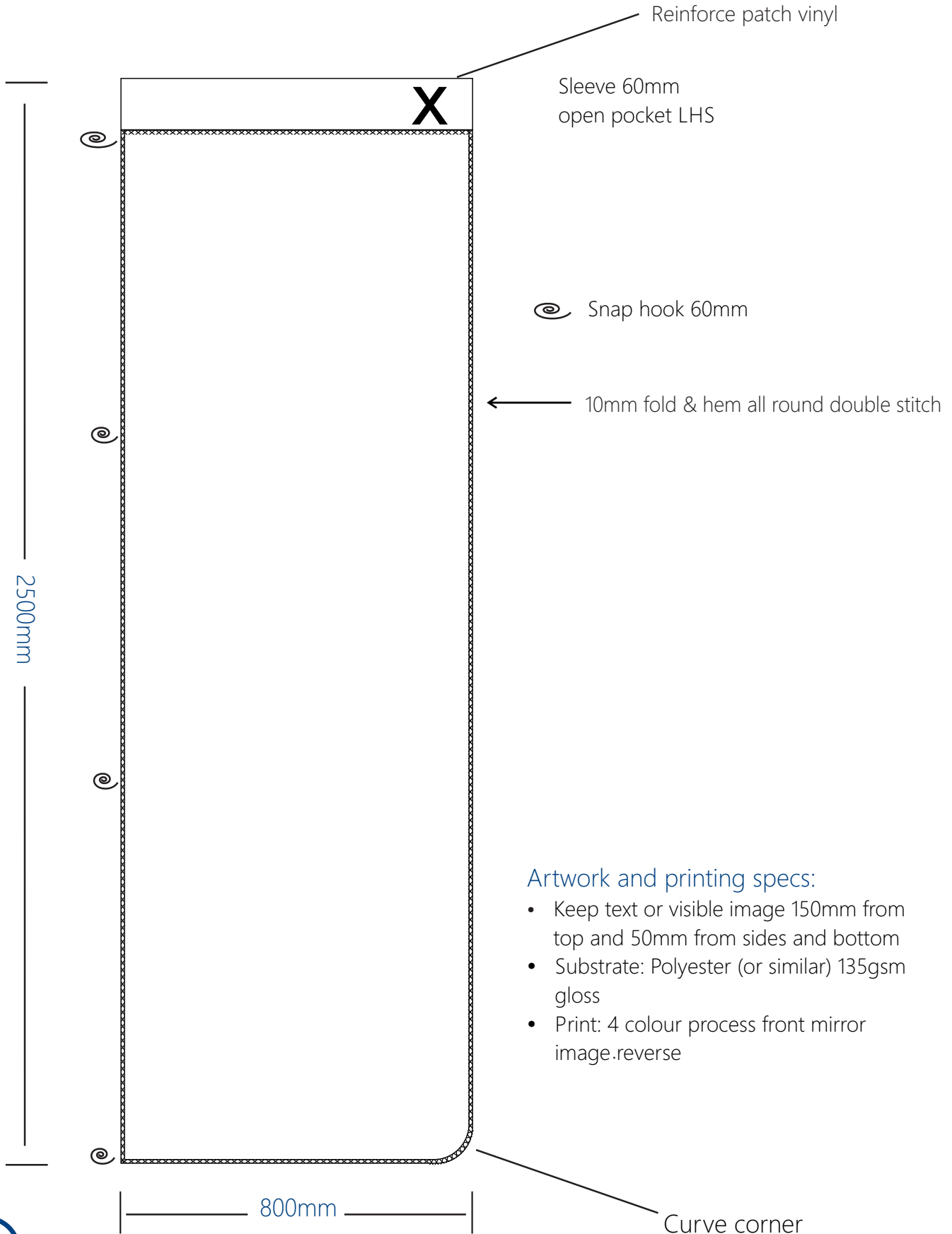

# 1000 x 3000mm Banner Pole

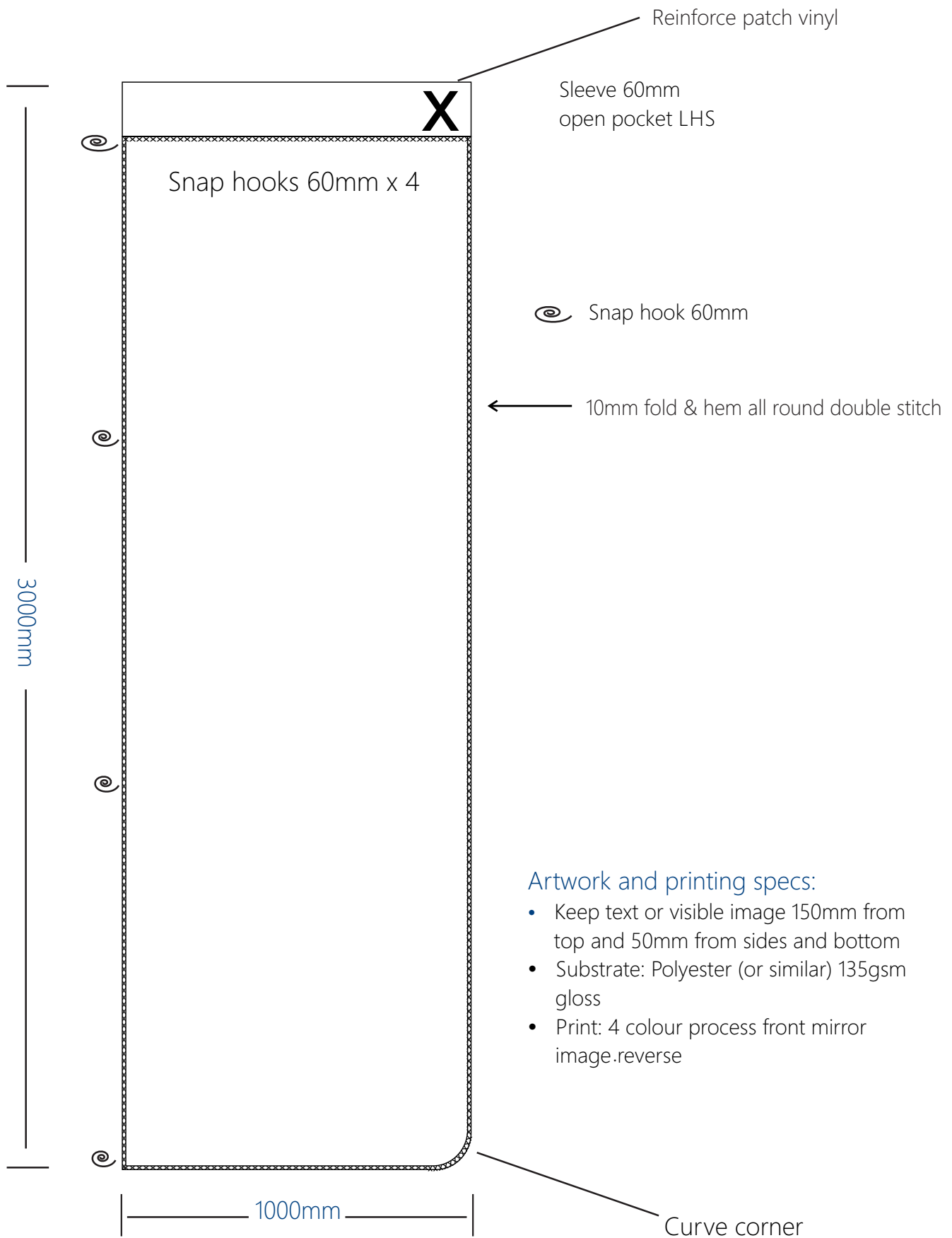

# 900 x 2700mm Banner Pole

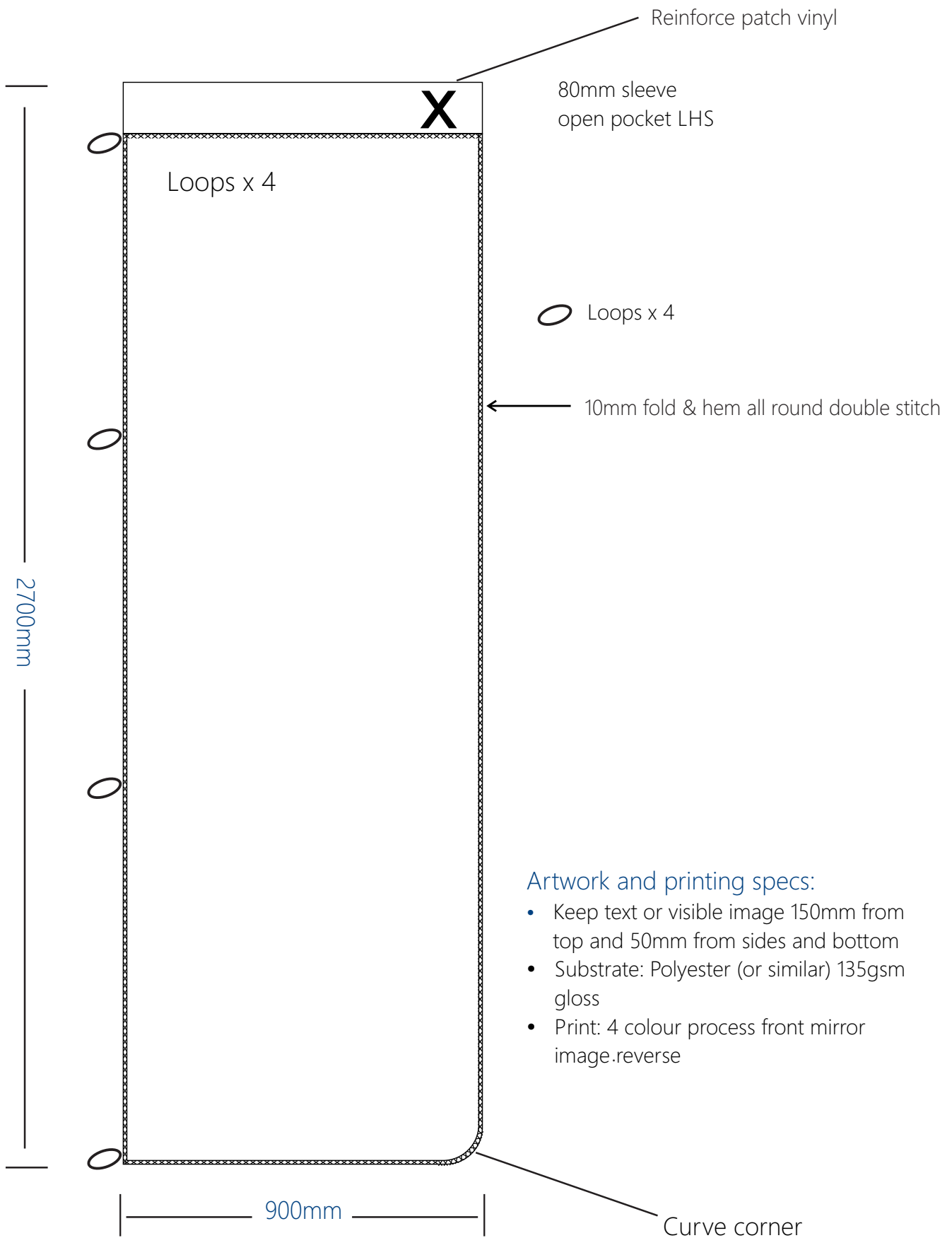



# 1500 x 4000mm Banner Pole

Flag extender pocket  
Reinforce patch vinyl

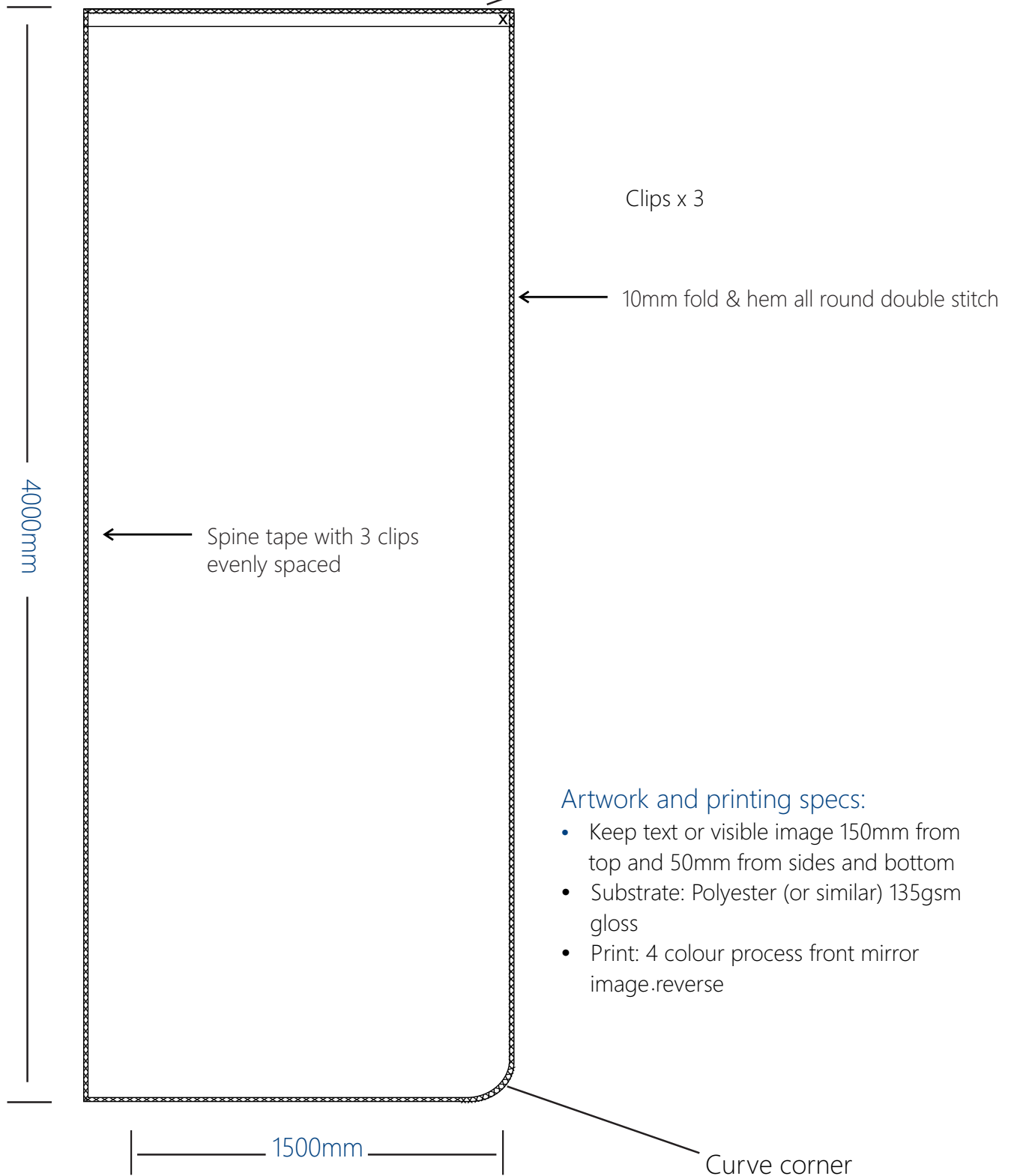

# Banner Stands

There is 1 x banner stand size across the LGA:

## 1000 x 5500mm Banner Stand

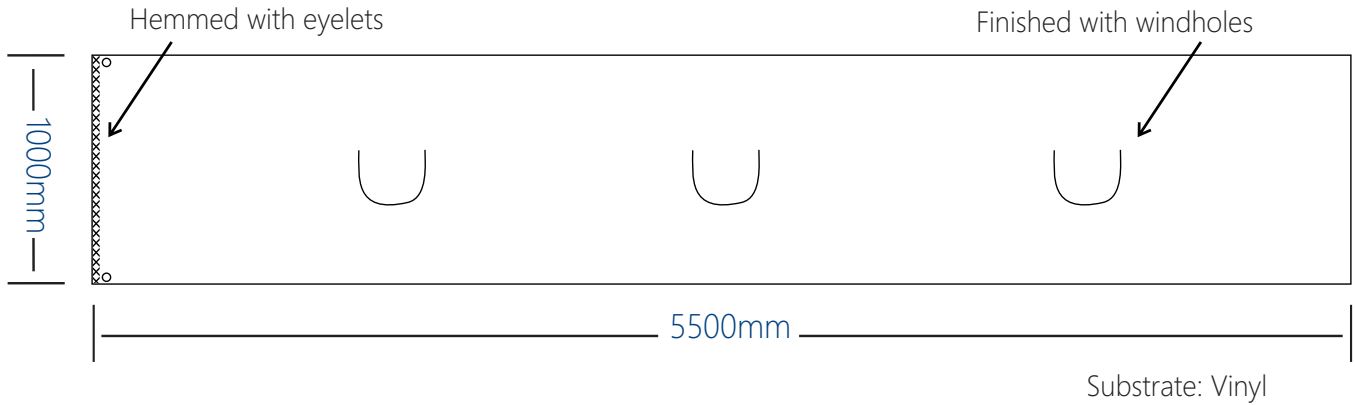

## Installation and De-Installation

Hirers are required to deliver their banners to the nominated Council site at least seven (7) days prior to installation. Install briefs and maps are to be provided to outline curation if more than one design is being used on banner poles.

Banner installation may experience delays such as traffic, weather conditions, the number of banners being installed as well as other external factors. Hirers should allow up to five (5) days variation on the installation date.

Hirers are responsible for collecting their banners from the nominated Council site as soon as they have been removed. Council will not be held responsible for any uncollected banners. Banners not collected within one month after de-install may be discarded.



## Central Coast Council Banner Guide

### Central Coast Council

2 Hely St / PO Box 20 Wyong NSW 2259

**P** 1300 463 954

[centralcoast.nsw.gov.au](http://centralcoast.nsw.gov.au)

ABN 73 149 644 003

November 2022